

No. STSE-CW2165A

<Cat.No.020826>

**SPECIFICATIONS FOR NICHIA WHITE LED**

**MODEL : NSPW515BS**

**NICHIA CORPORATION**

## 1.SPECIFICATIONS

### (1) Absolute Maximum Ratings (Ta=25°C)

Item	Symbol	Absolute Maximum Rating	Unit
Forward Current	IF	30	mA
Pulse Forward Current	IFP	100	mA
Reverse Voltage	VR	5	V
Power Dissipation	PD	120	mW
Operating Temperature	Topr	-30 ~ + 85	°C
Storage Temperature	Tstg	-40 ~ +100	°C
Soldering Temperature	Tsld	265°C for 10sec.	

IFP Conditions : Pulse Width  $\leq$  10msec. and Duty  $\leq$  1/10

### (2) Initial Electrical/Optical Characteristics (Ta=25°C)

Item	Symbol	Condition	Min.	Typ.	Max.	Unit	
Forward Voltage	VF	IF=20[mA]	-	3.6	4.0	V	
Reverse Current	IR	VR= 5[V]	-	-	50	$\mu$ A	
Luminous Intensity	Rank S	IV	IF=20[mA]	580	690	805	mcd
	Rank R	IV	IF=20[mA]	410	480	580	mcd
	Rank Q	IV	IF=20[mA]	290	345	410	mcd

\* Measurement Uncertainty of the Luminous Intensity :  $\pm$  10%

#### Color Ranks

(IF=20mA, Ta=25°C)

	Rank a0			
x	0.280	0.264	0.283	0.296
y	0.248	0.267	0.305	0.276

	Rank b1			
x	0.287	0.283	0.330	0.330
y	0.295	0.305	0.360	0.339

	Rank b2			
x	0.296	0.287	0.330	0.330
y	0.276	0.295	0.339	0.318

	Rank c0			
x	0.330	0.330	0.361	0.356
y	0.318	0.360	0.385	0.351

\* Measurement Uncertainty of the Color Coordinates :  $\pm$  0.01

\* One delivery will include up to two consecutive color ranks and three luminous intensity ranks of the products.  
The quantity-ratio of the ranks is decided by Nichia.

## 2.TYPICAL INITIAL OPTICAL/ELECTRICAL CHARACTERISTICS

Please refer to figure's page.

## 3.OUTLINE DIMENSIONS AND MATERIALS

Please refer to figure's page.

Material as follows ; Resin(Mold) : Epoxy Resin (over YAG Phosphor)  
Leadframe : Ag plating Copper Alloy

#### 4.PACKAGING

- The LEDs are packed in cardboard boxes after packaging in anti-electrostatic bags. According to the total delivery amount, cardboard boxes will be used to protect the LEDs from mechanical shocks during transportation. Please refer to figure's page. The label on the minimum packing unit bag shows;  
Part Number, Lot Number, Ranking, Quantity
- The boxes are not water resistant and therefore must be kept away from water and moisture.

#### 5.LOT NUMBER

The first six digits number shows **lot number**.

The lot number is composed of the following characters;

○□×××× - △■

- - Year ( 1 for 2001, 2 for 2002 )
- - Month ( 1 for Jan., 9 for Sep., A for Oct., B for Nov.)
- ×××× - Nichia's Product Number
- △ - Ranking by Color Coordinates
- - Ranking by Luminous Intensity

## 6.RELIABILITY

### (1) TEST ITEMS AND RESULTS

Test Item	Standard Test Method	Test Conditions	Note	Number of Damaged
Resistance to Soldering Heat	JEITA ED-4701 300 302	Tsld=260 ± 5°C, 10sec. 3mm from the base of the epoxy bulb	1 time	0/100
Solderability	JEITA ED-4701 300 303	Tsld=235 ± 5°C, 5sec. (using flux)	1 time over 95%	0/100
Thermal Shock	JEITA ED-4701 300 307	0°C ~ 100°C 15sec. 15sec.	100 cycles	0/100
Temperature Cycle	JEITA ED-4701 100 105	-40°C ~ 25°C ~ 100°C ~ 25°C 30min. 5min. 30min. 5min.	100 cycles	0/100
Moisture Resistance Cyclic	JEITA ED-4701 200 203	25°C ~ 65°C ~ -10°C 90%RH 24hrs./1cycle	10 cycles	0/100
Terminal Strength (bending test)	JEITA ED-4701 400 401	Load 5N (0.5kgf) 0° ~ 90° ~ 0° bend 2 times	Nonnoticeable damage	0/100
Terminal Strength (pull test)	JEITA ED-4701 400 401	Load 10N (1kgf) 10 ± 1 sec.	Nonnoticeable damage	0/100
High Temperature Storage	JEITA ED-4701 200 201	Ta=100°C	1000hrs.	0/100
Temperature Humidity Storage	JEITA ED-4701 100 103	Ta=60°C, RH=90%	1000hrs.	0/100
Low Temperature Storage	JEITA ED-4701 200 202	Ta=-40°C	1000hrs.	0/100
Steady State Operating Life		Ta=25°C, IF=30mA	1000hrs.	0/100
Steady State Operating Life of High Humidity Heat		60°C, RH=90%, IF=20mA	500hrs.	0/100
Steady State Operating Life of Low Temperature		Ta=-30°C, IF=20mA	1000hrs.	0/100

### (2) CRITERIA FOR JUDGING THE DAMAGE

Item	Symbol	Test Conditions	Criteria for Judgement	
			Min.	Max.
Forward Voltage	V <sub>F</sub>	I <sub>F</sub> =20mA	-	U.S.L.*) × 1.1
Reverse Current	I <sub>R</sub>	V <sub>R</sub> =5V	-	U.S.L.*) × 2.0
Luminous Intensity	I <sub>V</sub>	I <sub>F</sub> =20mA	L.S.L.***) × 0.7	-

\*) U.S.L. : Upper Standard Level

\*\*) L.S.L. : Lower Standard Level

## 7.CAUTIONS

White LEDs are devices which are materialized by combining Blue LEDs and special phosphors. Consequently, the color of White LEDs is changed a little by an operating current. Care should be taken after due consideration when using LEDs.

### (1) Lead Forming

- When forming leads, the leads should be bent at a point at least 3mm from the base of the epoxy bulb. Do not use the base of the leadframe as a fulcrum during lead forming.
- Lead forming should be done before soldering.
- Do not apply any bending stress to the base of the lead. The stress to the base may damage the characteristics or it may break the LEDs.
- When mounting the LEDs onto a printed circuit board, the holes on the circuit board should be exactly aligned with the leads of the LEDs. If the LEDs are mounted with stress at the leads, it causes deterioration of the epoxy resin and this will degrade the LEDs.

### (2) Storage

- The LEDs should be stored at 30°C or less and 70%RH or less after being shipped from Nichia and the storage life limits are 3 months. If the LEDs are stored for 3 months or more, they can be stored for a year in a sealed container with a nitrogen atmosphere and moisture absorbent material.
- Nichia LED leadframes are comprised of a silver plated copper alloy. The silver surface may be affected by environments which contain corrosive gases and so on. Please avoid conditions which may cause the LED to corrode, tarnish or discolor. This corrosion or discoloration may cause difficulty during soldering operations. It is recommended that the LEDs be used as soon as possible.
- Please avoid rapid transitions in ambient temperature, especially, in high humidity environments where condensation can occur.

### (3) Static Electricity

- Static electricity or surge voltage damages the LEDs. It is recommended that a wrist band or an anti-electrostatic glove be used when handling the LEDs.
- All devices, equipment and machinery must be properly grounded. It is recommended that measures be taken against surge voltage to the equipment that mounts the LEDs.
- When inspecting the final products in which LEDs were assembled, it is recommended to check whether the assembled LEDs are damaged by static electricity or not. It is easy to find static-damaged LEDs by a light-on test or a VF test at a lower current (below 1mA is recommended).
- Damaged LEDs will show some unusual characteristics such as the leak current remarkably increases, the forward voltage becomes lower, or the LEDs do not light at the low current.

Criteria : (VF > 2.0V at IF=0.5mA)

(4) Soldering Conditions

- Nichia LED leadframes are comprised of a silver plated copper alloy. This substance has a low thermal coefficient (easily conducts heat). Careful attention should be paid during soldering.
- Solder the LED no closer than 3mm from the base of the epoxy bulb. Soldering beyond the base of the tie bar is recommended.
- Recommended soldering conditions

Dip Soldering		Soldering	
Pre-Heat	100°C Max.	Temperature	300°C Max.
Pre-Heat Time	60 seconds Max.	Soldering Time	3 seconds Max.
Solder Bath Temperature	260°C Max.	Position	No closer than 3 mm from the base of the epoxy bulb.
Dipping Time	10 seconds Max.		
Dipping Position	No lower than 3 mm from the base of the epoxy bulb.		

- Do not apply any stress to the lead particularly when heated.
- The LEDs must not be repositioned after soldering.
- After soldering the LEDs, the epoxy bulb should be protected from mechanical shock or vibration until the LEDs return to room temperature.
- Direct soldering onto a PC board should be avoided. Mechanical stress to the resin may be caused from warping of the PC board or from the clinching and cutting of the leadframes. When it is absolutely necessary, the LEDs may be mounted in this fashion but the User will assume responsibility for any problems. Direct soldering should only be done after testing has confirmed that no damage, such as wire bond failure or resin deterioration, will occur. Nichia's LEDs should not be soldered directly to double sided PC boards because the heat will deteriorate the epoxy resin.
- When it is necessary to clamp the LEDs to prevent soldering failure, it is important to minimize the mechanical stress on the LEDs.
- Cut the LED leadframes at room temperature. Cutting the leadframes at high temperatures may cause failure of the LEDs.

(5) Heat Generation

- Thermal design of the end product is of paramount importance. Please consider the heat generation of the LED when making the system design. The coefficient of temperature increase per input electric power is affected by the thermal resistance of the circuit board and density of LED placement on the board, as well as other components. It is necessary to avoid intense heat generation and operate within the maximum ratings given in this specification.
- The operating current should be decided after considering the ambient maximum temperature of LEDs.

(6) Cleaning

- It is recommended that isopropyl alcohol be used as a solvent for cleaning the LEDs. When using other solvents, it should be confirmed beforehand whether the solvents will dissolve the resin or not. Freon solvents should not be used to clean the LEDs because of worldwide regulations.
- Do not clean the LEDs by the ultrasonic. When it is absolutely necessary, the influence of ultrasonic cleaning on the LEDs depends on factors such as ultrasonic power and the assembled condition. Before cleaning, a pre-test should be done to confirm whether any damage to the LEDs will occur.

(7) Safety Guideline for Human Eyes

- In 1993, the International Electric Committee (IEC) issued a standard concerning laser product safety (IEC 825-1). Since then, this standard has been applied for diffused light sources (LEDs) as well as lasers. In 1998 IEC 60825-1 Edition 1.1 evaluated the magnitude of the light source. In 2001 IEC 60825-1 Amendment 2 converted the laser class into 7 classes for end products. Components are excluded from this system. Products which contain visible LEDs are now classified as class 1. Products containing UV LEDs are class 1M. Products containing LEDs can be classified as class 2 in cases where viewing angles are narrow, optical manipulation intensifies the light, and/or the energy emitted is high. For these systems it is recommended to avoid long term exposure. It is also recommended to follow the IEC regulations regarding safety and labeling of products.

(8) Others

- Care must be taken to ensure that the reverse voltage will not exceed the absolute maximum rating when using the LEDs with matrix drive.
- The LEDs described in this brochure are intended to be used for ordinary electronic equipment (such as office equipment, communications equipment, measurement instruments and household appliances). Consult Nichia's sales staff in advance for information on the applications in which exceptional quality and reliability are required, particularly when the failure or malfunction of the LEDs may directly jeopardize life or health (such as for airplanes, aerospace, submersible repeaters, nuclear reactor control systems, automobiles, traffic control equipment, life support systems and safety devices).
- User shall not reverse engineer by disassembling or analysis of the LEDs without having prior written consent from Nichia. When defective LEDs are found, the User shall inform Nichia directly before disassembling or analysis.
- The formal specifications must be exchanged and signed by both parties before large volume purchase begins.
- The appearance and specifications of the product may be modified for improvement without notice.

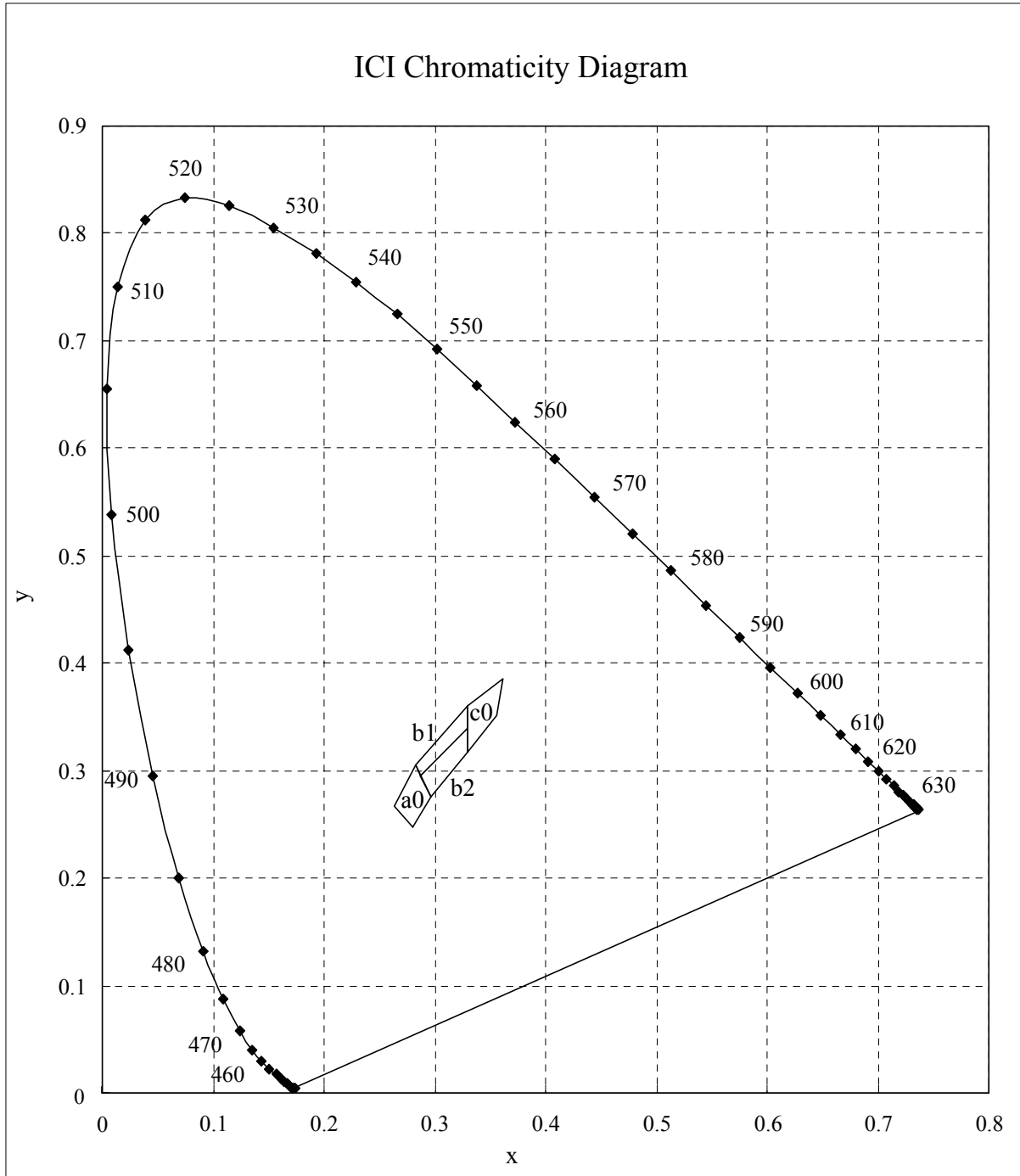



■ Forward Voltage vs. Forward Current

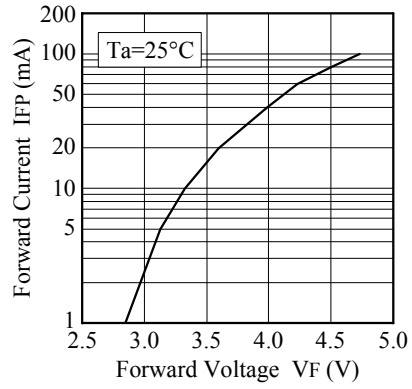

■ Forward Current vs. Relative Luminosity

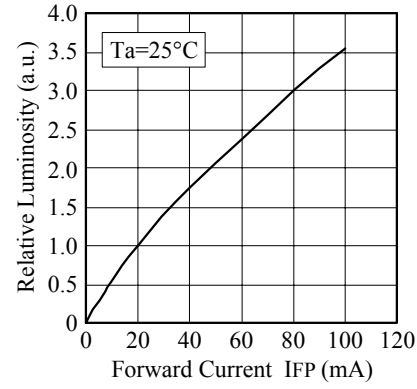

■ Duty Ratio vs. Allowable Forward Current

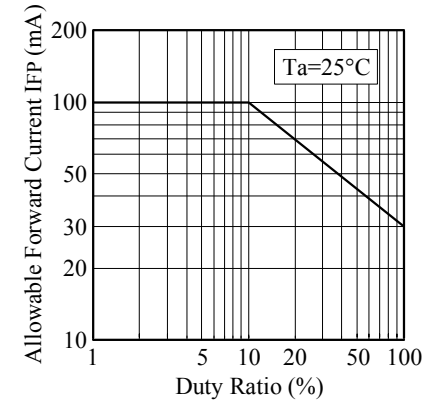

■ Ambient Temperature vs. Forward Voltage

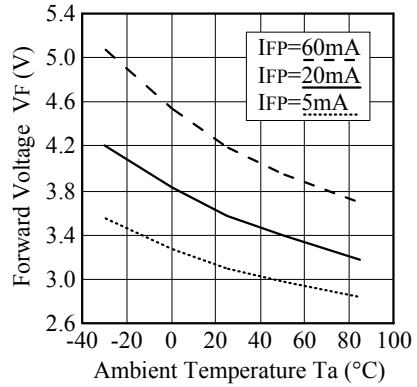

■ Ambient Temperature vs. Relative Luminosity

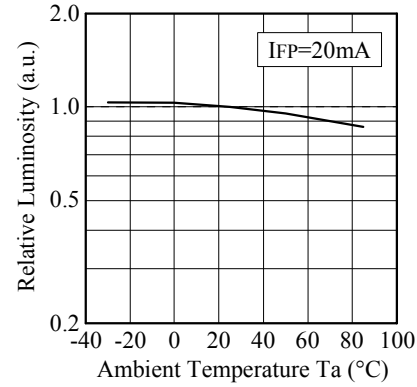

■ Ambient Temperature vs. Allowable Forward Current

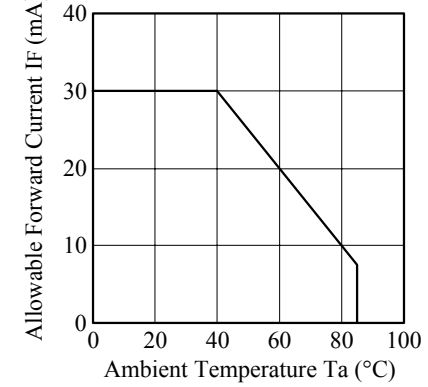

NICHIA CORPORATION	Model	NSPWxxxx
	Title	TYP.CHARACTERISTICS
	No.	011210110251

■ Forward Current vs. Chromaticity diagram

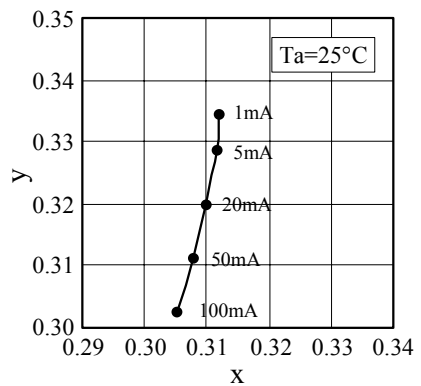

■ Spectrum

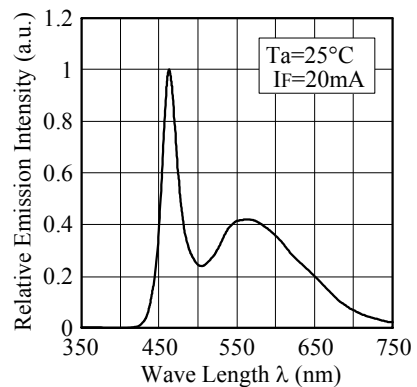

■ Ambient Temperature vs. Chromaticity diagram

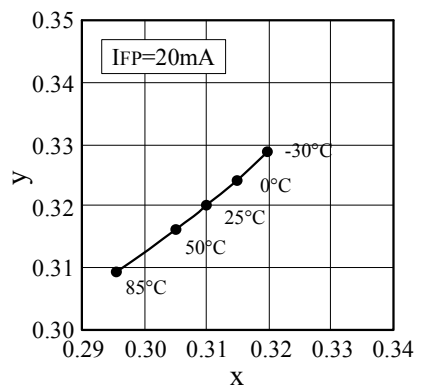

■ Directivity (NSPW515B(S))

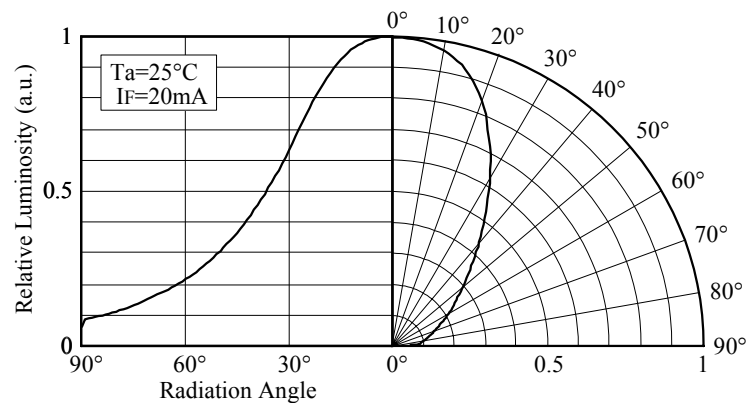

NICHIA CORPORATION	Model	NSPW515B(S)
	Title	TYP.CHARACTERISTICS
	No.	020214110322

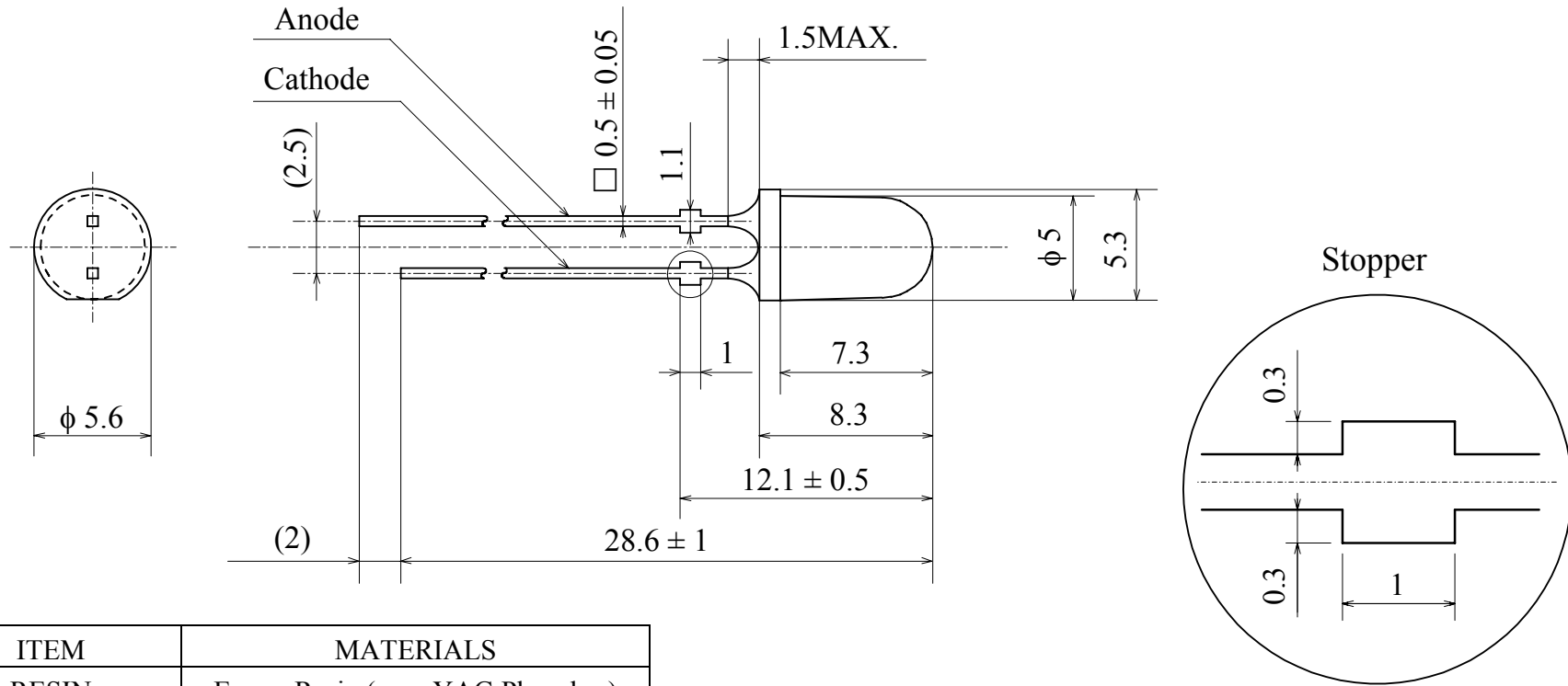

ITEM	MATERIALS
RESIN	Epoxy Resin (over YAG Phosphor)
LENS COLOR	Milky (Diffusion type)
LEAD FRAME	Ag Plating Copper Alloy

Remark:

Bare copper alloy is exposed at tie-bar portion after cutting.  
 The lamps have sharp and hard points that may injure human eyes or fingers etc., so please pay enough care in the handling.

NICHIA CORPORATION	Model	NSPW515BS	Unit mm 3/1 Scale
	Title	OUTLINE DIMENSIONS	
	No.	010817105001	Allow ± 0.2

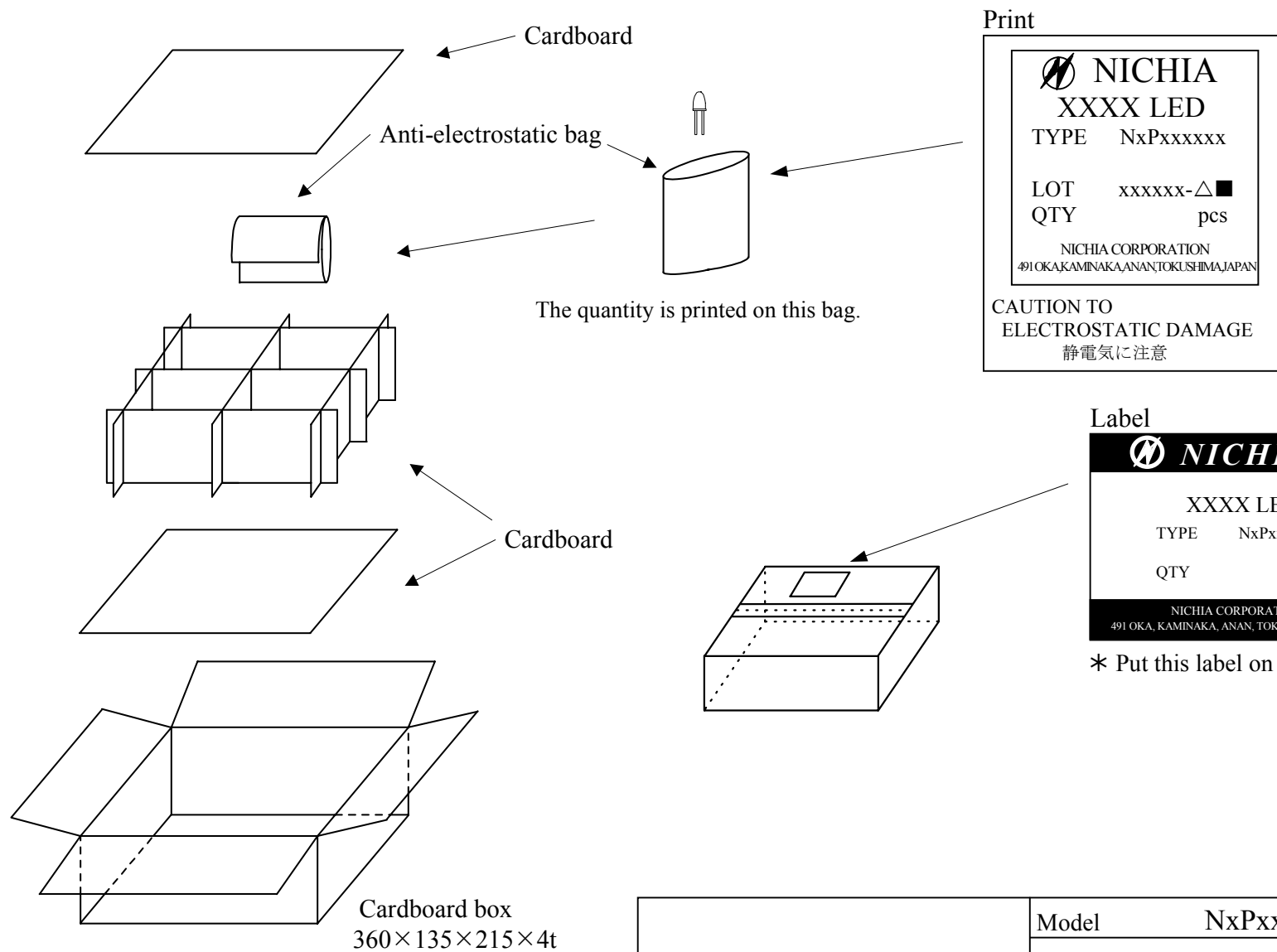

\* One box contains 8 bags at maximum.

NICHIA CORPORATION	Model	NxPxxxxxx	
	Title	PACKING	
	No.	020723201101	

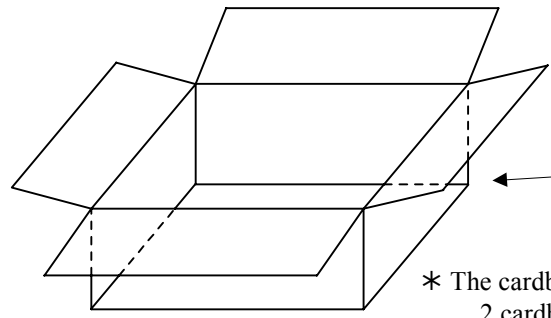
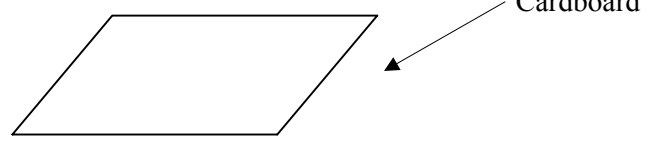
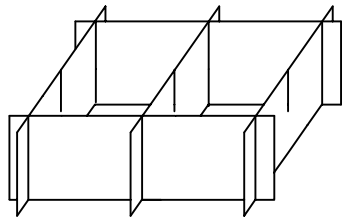
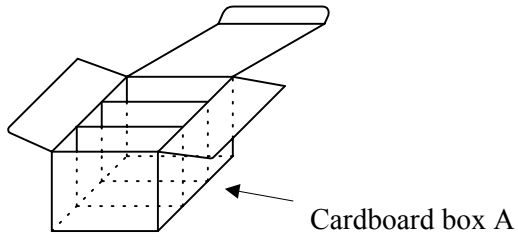
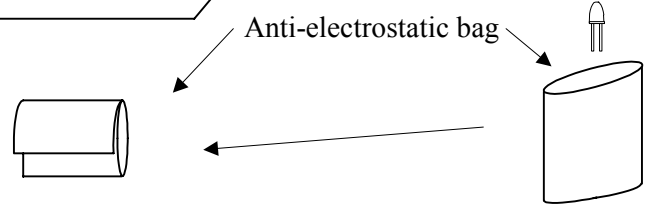

Cardboard box B  
360×135×215×4t

\* The cardboard box B contains  
2 cardboard box A at maximum.

The quantity is printed on this bag.

Print



Label

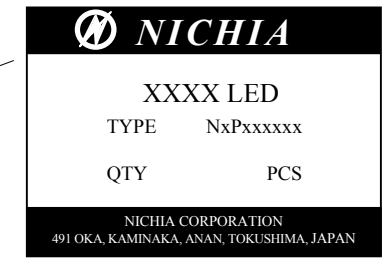

\* Put this label on the cardboard box B.

NICHIA CORPORATION	Model	NxPxxxxxx	STSE-CW2165A <Cat.No.020826>
	Title	PACKING	
	No.	020723201111	

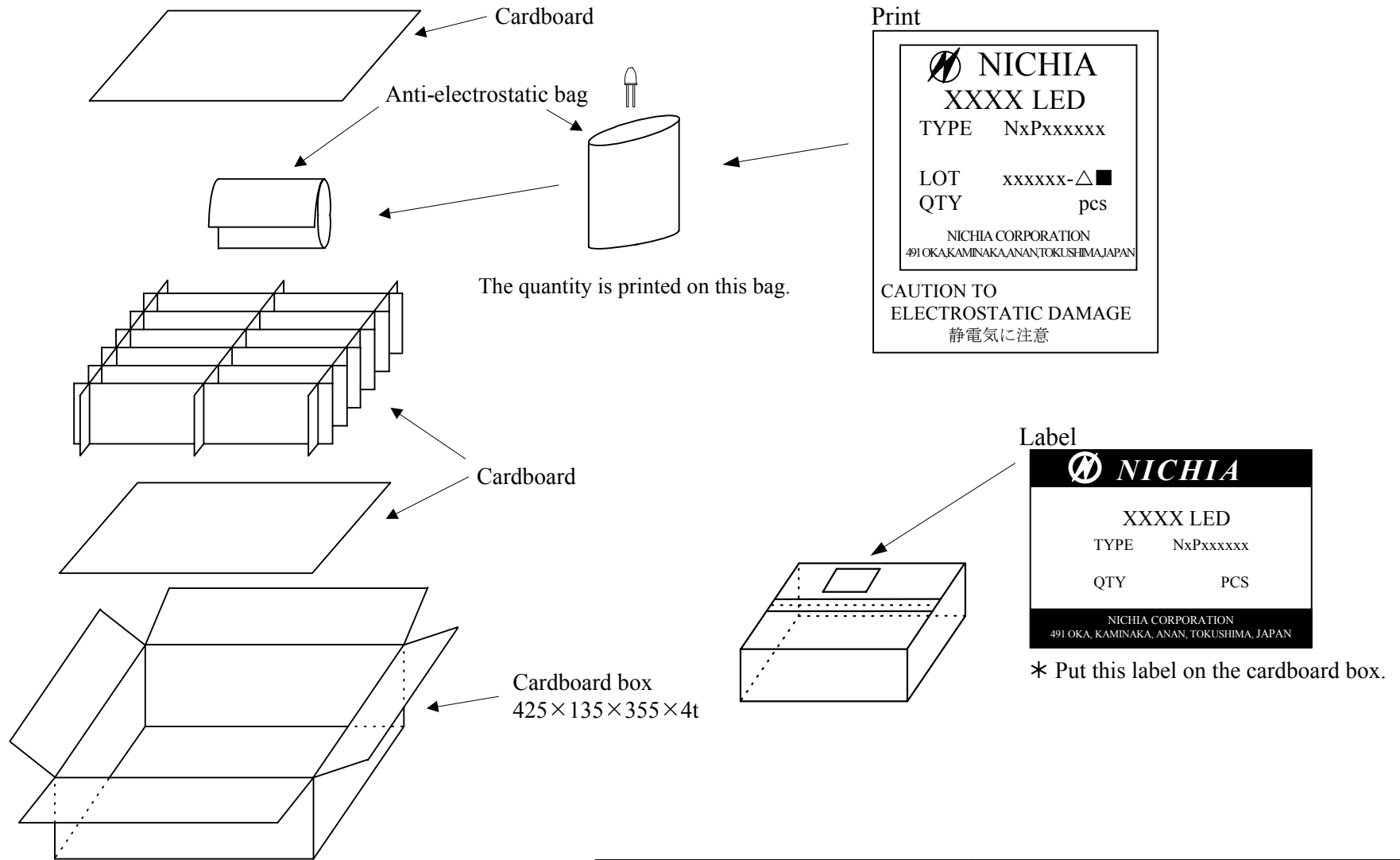

\* One box contains 20 bags at maximum.

<b>NICHIA CORPORATION</b>	Model	NXPxxxxxx	STSE-CW2165A <Cat.No. 020826>
	Title	PACKING	
	No.	020723201121	

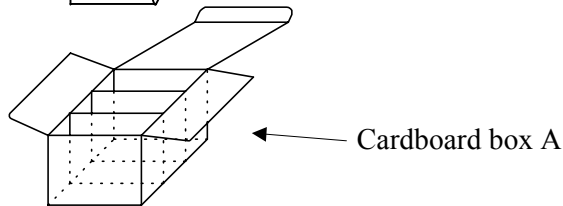
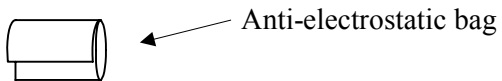
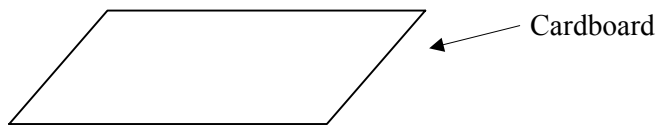

The quantity is printed on this bag.

Print

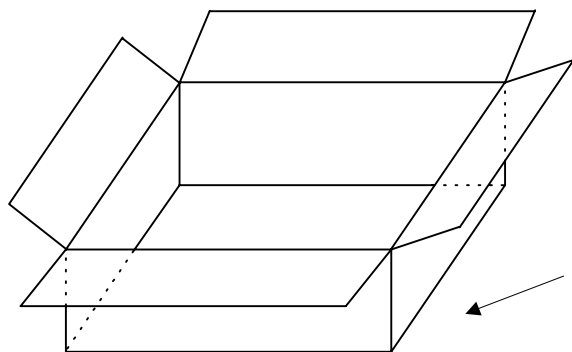
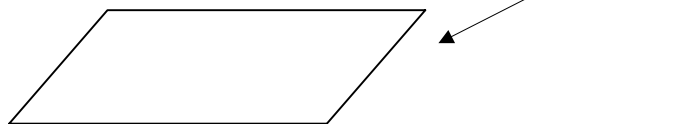
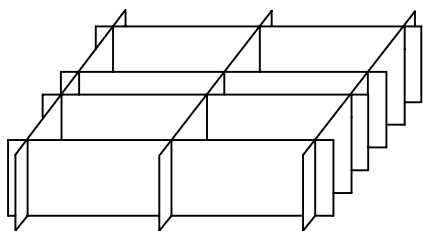

Cardboard box B  
425×135×355×4t

Label



\* Put this label on the cardboard box B.

NICHIA CORPORATION	Model	NxPxxxxxx	STSE-CW2165A <Cat.No.020826>
	Title	PACKING	
	No.	020723201131	

\* The cardboard box B contains 4 cardboard box A at maximum.